

Removable Sleeve, Locknut and Lockwasher | AN/19/SK/8523/AN/15/W/15

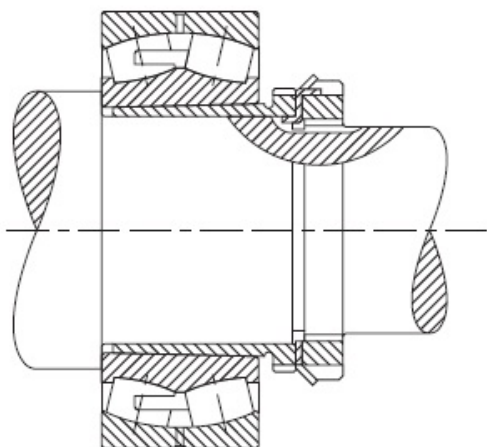

Bearing No. AN/19/SK/8523/AN/15/W/15

Weight	AN-19
Bearing Number	-0.10 mm-0.004 in
Housing Construction	1:12
UPC Code	2.25 lb1.02 Kg
Shaft Size Type	SK-8523
Full Timken Part Number	223K
Locking Style	125.55 mm4.943 in
Y2 - Geometry Factor	93.35 mm3.675 in
Y1 - Geometry Factor	W-15
Shaft Tolerance	AN-15
Shaft Size	75.00 mm2.953 in
Pre Install Clearance Min	75 mm2.9528 in
Pre Install Clearance Max	22317K