

Removable Sleeve, Locknut and Lockwasher | AN/20/SK/9023/AN/16/W/16

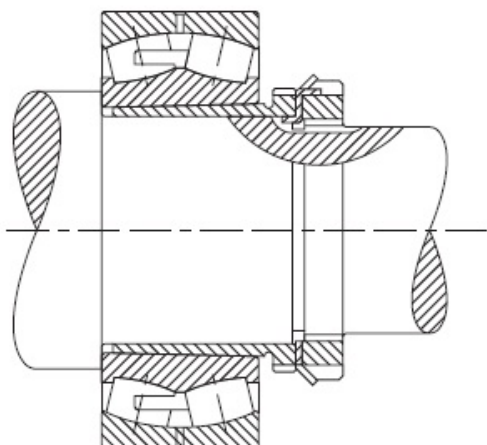

Bearing No. AN/20/SK/9023/AN/16/W/16

Weight	AN-20
Bearing Number	-0.10 mm-0.004 in
Housing Construction	1:12
UPC Code	2.55 lb1.16 Kg
Shaft Size Type	SK-9023
Full Timken Part Number	223K
Locking Style	131.90 mm5.193 in
Y2 - Geometry Factor	98.12 mm3.863 in
Y1 - Geometry Factor	W-16
Shaft Tolerance	AN-16
Shaft Size	80.00 mm3.150 in
Pre Install Clearance Min	80 mm3.1496 in
Pre Install Clearance Max	22318K