

Removable Sleeve, Locknut and Lockwasher | RN/32/SK/16022/AN/28/W/28

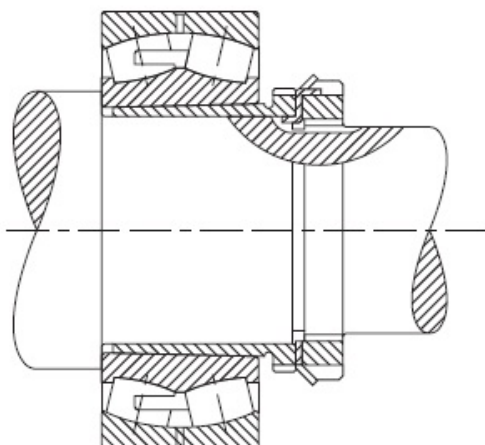

Bearing No. RN/32/SK/16022/AN/28/W/28

Weight	RN-32
Bearing Number	-0.13 mm-0.005 in
Housing Construction	1:12
UPC Code	9.95 lb4.51 Kg
Shaft Size Type	SK-16022
Full Timken Part Number	222K
Locking Style	227.03 mm8.938 in
Y2 - Geometry Factor	173.76 mm6.841 in
Y1 - Geometry Factor	W-28
Shaft Tolerance	AN-28
Shaft Size	96.00 mm3.780 in
Pre Install Clearance Min	140 mm5.5118 in
Pre Install Clearance Max	22232K