

Bearing No. 53316

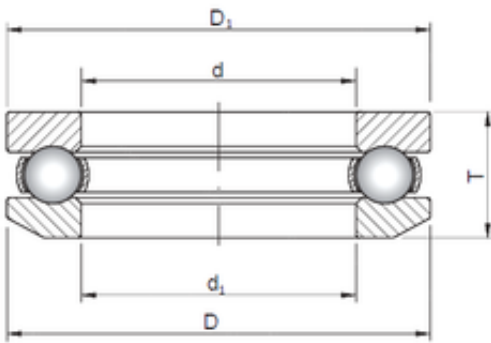

d	80 mm
D	140 mm
T	47,6 mm
d1	82 mm
D1	140 mm
Weight	2,86 Kg
Bearing number	53316
Bore Diameter (mm)	80
Outer Diameter (mm)	140
(Grease) Lubrication Speed	1200 r/min
Basic dynamic load rating (C)	176 kN
Basic static load rating (C0)	424 kN