

Bearing No. 51416

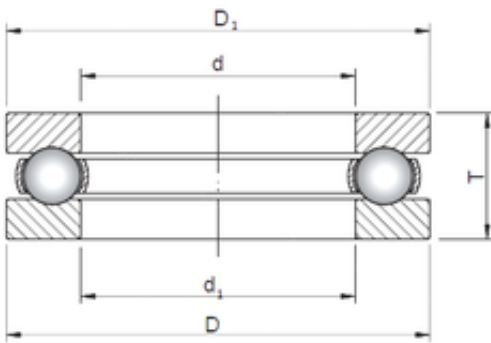

d	80 mm
D	170 mm
T	68 mm
d1	83 mm
D1	170 mm
Weight	7,95 Kg
Bearing number	51416
Bore Diameter (mm)	80
Outer Diameter (mm)	170
(Grease) Lubrication Speed	850 r/min
Basic dynamic load rating (C)	270 kN
Basic static load rating (C0)	620 kN