

Bearing No. 51413

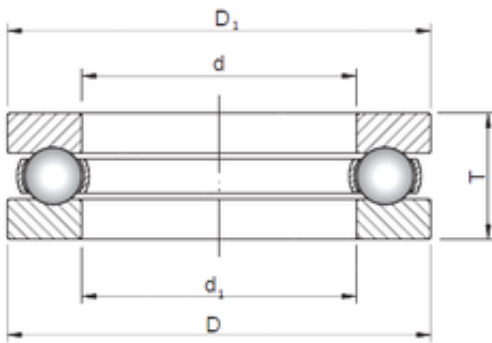

d	65 mm
D	140 mm
T	56 mm
d1	68 mm
D1	140 mm
Weight	4 Kg
Bearing number	51413
Bore Diameter (mm)	65
Outer Diameter (mm)	140
(Grease) Lubrication Speed	1000 r/min
Basic dynamic load rating (C)	216 kN
Basic static load rating (C0)	450 kN