

Bearing No. B-3210

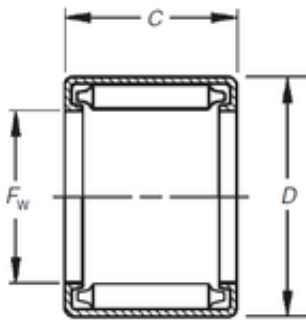

D	60,325 mm
C	15,88 mm
F _w	50,8 mm
Weight	0,078 Kg
Size (mm)	50.8x60.325x15.88
Width (mm)	15,88
Bearing number	B-3210
Bore Diameter (mm)	50,8
Outer Diameter (mm)	60,325
(Grease) Lubrication Speed	2200 r/min
Basic dynamic load rating (C)	34,2 kN
Basic static load rating (C ₀)	70,7 kN