

Bearing No. E-EE833161D/833232/833233D

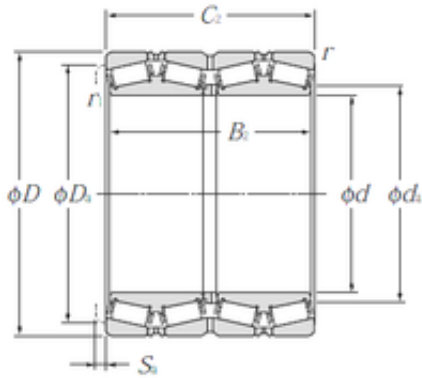

D	590,55 mm
d	406,4 mm
B	400,05 mm
C	400,05 mm
Da	549 mm
da	448 mm
Sa	6,5 mm
r min.	6,4 mm
Weight	395 Kg
r1 min.	3,3 mm
Size (mm)	406.4x590.55x400.05
Width (mm)	400,05
Bearing number	E-EE833161D/833232/833233D
Bore Diameter (mm)	406,4
Outer Diameter (mm)	590,55
Basic dynamic load rating (C)	4 850 kN